

**LMX.**

# Introduction

For more than 10 years, Lifemaxx has been designing, manufacturing and supplying commercial grade fitness accessories throughout Europe. Within this period our clients have always been our source for information and inspiration to make existing designs better and create innovative new products.

The last few years we expanded our product range significantly due to the continuous changing fitness market and the trend towards functional training. Our newest brand Crossmaxx<sup>®</sup>, specialized in functional training products, now offers a complete solution for all functional training areas. This year we are proud to launch our new line of poly urethane dumbbells, barbells and weightplates. These products are designed with an eye on functionality: they do not roll away and the marking of the weight is on all sides. We even made the dumbbell rack for the smaller weights look like a piece of art!

From our Rotterdam warehouse we are able to supply our clients with high quality products at competitive prices. We hold a high stock level and being in the heart of Europe gives us the advantage to offer our clients quick deliveries and great service. With healthy regards on behalf of the Lifemaxx team,

Denise Doolhof & Diederick Goede

# Contents

<b>Free Weights</b>	8 - 13
Dumbbells	5 - 6
Barbells	6
Weight plates	7 - 8
Kettlebells	8 - 9
<b>Bars</b>	10 - 11
Olympic bars	11
Specialty bars	12
Bars (Ø30mm)	13
<b>Accessories</b>	14 - 21
Cable attachments	15 - 16
Fitness accessories	17 - 19
Training accessories	20 - 21
<b>Functional Training &amp; Groupfitness</b>	22 - 35
<b>Racks &amp; Benches</b>	36 - 49
Free weight racks	37 - 41
Functional training & Groupfitness racks	42 - 46
Benches	47 - 49
<b>Lifemaxx Functional Rack</b>	50 - 58
Large & Small	51 - 57
Wall Rack	58
<b>Fanatic</b>	59
<b>Floors</b>	60 - 61
<b>Crossmaxx</b>	62 - 95
Olympic bars	63 - 64
Jerk blocks	64
Platform	64
Bumper plates	66
Collars & Chains	67
Dumbbells, Kettlebells, Core training	69
Air Bike Pro	70 - 71
Gymnastic & Conditioning	73 - 75
Mobility & Training accessories	76 - 79
Racks & Benches	80 - 83
Floors	84 - 85
Rigs & Accessories	86 - 95

Keep in touch through our Facebook and Instagram pages and read about our latest updates, innovations, events and client experiences.



[/Lifemaxxfitness](#)  
[/Crossmaxxfitness](#)



[/Lifemaxxfitness](#)

# FREE WEIGHTS

Dumbbells | Barbells | Weight plates | Kettlebells



## Dumbbells



### LMX72 Lifemaxx PU dumbbells

Poly urethane | Per set | 1 to 10 KG, 1 KG increment  
12 to 60 KG, 2 KG increment | 3 years warranty



### LMX75 Dumbbells

Rubber | Per set | 2 to 10 KG, 1 KG increment  
12 to 60 KG, 2 KG increment | 1 year warranty



### LMX75C Contoured dumbbells

Rubber | Per set | 2 to 10 KG, 1 KG increment | 12 to 60 KG, 2 KG  
increment | Contoured grip | 1 year warranty



### LMX79 Fixed dumbbells

Rubber | Per set | 1 to 10 KG, 1 KG increment  
12 to 60 KG, 2 KG increment | 12,5 to 40 KG, 2,5 KG increment  
1 year warranty



### LMX94 Lifemaxx® PU dumbbell tower

Dimensions : L: 720 x VV: 480 x H: 1600mm | Suitable for 10 sets of  
dumbbells (LMX72 series) | Fillable with water or sand for even more  
stability | Without dumbbells | Colour: black



### LMX79 SD Dumbbelltower with fixed dumbbellset 1-10kg

### LMX80 SD Dumbbelltower

with chrome dumbbellset 1-10kg

## Dumbbells



**LMX80 Chrome dumbbells**  
Chromed | Per set | 1 to 10 KG, 1 KG increment  
1 year warranty



**LMX81 Hexagon dumbbells**  
Rubber | Per set | 2.5 to 40 KG, 2.5 KG increment  
1 year warranty

## Weight plates



**LMX73 Lifemaxx PU Olympic disc**  
Ø50mm | Polyurethane | Available in the following weights: 1.25, 2.5, 5, 10, 15, 20, 25 KG | Stainless steel inserts | Per piece | 3 years warranty



**LMX92 Olympic disc 5-grip model**  
Ø50mm | Rubber | Available in the following weights: 1.25, 2.5, 5, 10, 15, 20, 25 KG | Stainless steel inserts | Per piece | 1 year warranty

## Barbells



**LMX74 PU EZ & Straight barbells**  
Polyurethane | 10 to 40 KG, 5 KG increment  
1 year warranty



**LMX77 Straight barbell**  
Rubber | 10 to 50 KG, 1 KG increment  
1 year warranty



**LMX76 Fixed EZ & Straight barbells**  
Rubber | 10 to 40 KG, 5 KG increment  
1 year warranty



**LMX78 EZ barbell**  
Rubber | 10 to 50 KG, 1 KG increment  
1 year warranty



**LMX86 Olympic disc (black)**  
Ø50mm | Rubber | Available in the following weights: 1.25, 2.5, 5, 10, 15, 20, 25 KG | Stainless steel inserts | Per piece | 1 year warranty



**LMX87 Crossmaxx® Bumper plate**  
Ø50mm | Rubber | Available in the following weights: 5, 10, 15, 20, 25 KG | Stainless steel inserts | Per piece | 1 year warranty



**LMX85C Crossmaxx® Competition bumper plate (coloured)**  
Ø50mm | Rubber | Available in the following weights: 10, 15, 20, 25 KG | Stainless steel inserts | Per piece | 1 year warranty



**LMX86C Olympic disc (coloured)**  
Ø50mm | Rubber | Available in the following weights: 10, 15, 20, 25 KG | Stainless steel inserts | Per piece | 1 year warranty



**LMX87 025 Crossmaxx® Technique plate**  
Ø50mm | PVC | Available in 2.5 KG | Plate Ø 45mm



**LMX85 Crossmaxx® Competition bumper plate (black)**  
Ø50mm | Rubber | Available in the following weights: 5, 10, 15, 20, 25 KG | Stainless steel inserts | Per piece | 1 year warranty

## Weight plates



**LMX83 Crossmaxx® Fractional plate**  
 Ø50mm | Rubber | Available in the following weights: 0.5, 1, 1.5, 2, 2.5 KG | Per piece | 1 year warranty



**LMX1132 Body pump disc**  
 Ø30mm | Rubber | Available in the following weights: 1,25, 2,5, 5, 10 KG | Per piece | 1 year warranty | Also available as full set LMX1129



**LMX84 Disc**  
 Ø30mm | Rubber | Available in the following weights: 0,5, 1, 1,25, 1,5, 2, 2,5, 3, 4, 5, 10, 15 KG | Per piece | 1 year warranty

## Kettlebells



**LMX88 Crossmaxx® Competition kettlebell**  
 Steel | Available in the following weights: 8, 12, 16, 20, 24, 28, 32 KG | Handle Ø33mm | Per piece



**LMX89 Rubber kettlebell**  
 Rubber | Available in the following weights: 4, 8, 12, 16, 20, 24, 28 KG | Per piece



**LMX90 Cast iron kettlebell**  
 Iron | With rubber feet | Available in the following weights: 4, 6, 8, 12, 16, 20, 24, 28, 32, 36, 40, 44, 50 KG | Per piece



**LMX91 Aerobic kettlebell**  
 PVC | With rubber feet | Available in the following weights: 2, 3, 4, 6, 8, 10, 12, 14, 16, 18, 20 KG | Per piece



**LMX93 Crossmaxx® Powdercoated kettlebell**  
 Iron | Available in the following weights: 4, 8, 12, 16, 20, 24, 28, 32, 36, 40 KG | Per piece



# BARs

Olympic bars | Specialty bars | Bars (Ø30mm)



## Olympic bars



**LMX30** Olympic competition bar  
Length: 2200mm | Handle Ø28mm | Sleeve Ø50mm  
Weight: 20 KG | Maximum load: 675 KG | Spring steel  
Bearing type: Needle | Brushed steel finishing | PSI: 210000



**LMX38** Olympic competition women's bar  
Length: 2010mm | Handle Ø25mm | Sleeve Ø50mm  
Weight: 15 KG | Maximum load: 475 KG | Spring steel  
Bearing type: Needle | Brushed steel finishing | PSI: 210000



**LMX43** Crossmaxx® Olympic compact competition bar  
Length: 1780mm | Handle Ø28,5mm | Sleeve Ø50mm | Weight: 16 KG  
Maximum load: 2000LB | Spring steel | Bearing type: Needle - 4 per sleeve | Black oxide and hard chrome finishing | PSI: 205000



**LMX42** Olympic bar 50mm 185cm  
Length: 1850mm | Handle Ø30mm | Sleeve Ø50mm | Weight: 16 KG  
Maximum load: 315 KG | Bearing type: Bushing | Brushed steel finishing



**LMX33** Olympic EZ bar 50mm 120cm  
Length: 1200mm | Handle Ø30mm | Sleeve Ø50mm | Weight: 8 KG  
Maximum load: 315 KG | Bearing type: Needle | Brushed steel finishing



**LMX34** Crossmaxx® Olympic competition bar (black/chrome)  
Length: 2200mm | Handle Ø28mm | Sleeve Ø50mm | Weight: 20 KG  
Maximum load: 2000LB | Spring steel | Bearing type: Needle - 4 per sleeve | Black oxide and hard chrome finishing | PSI: 205000



**LMX44** Crossmaxx® Olympic competition women's bar (black/chrome)  
Length: 2010mm | Handle Ø25mm | Sleeve Ø50mm | Weight: 15 KG  
Maximum load: 1200LB | Spring steel | Bearing type: Needle - 4 per sleeve | Black oxide and hard chrome finishing | PSI: 205000



**LMX31.01** Olympic bar  
Length: 2200mm | Handle Ø30mm | Sleeve Ø50mm | Weight: 20 KG  
Maximum load: 315 KG | Bearing type: Bushing | Brushed steel finishing



**LMX32** Olympic bar 150cm  
Length: 1500mm | Handle Ø30mm | Sleeve Ø50mm | Weight: 12 KG  
Maximum load: 315 KG | Bearing type: Needle | Brushed steel finishing



**LMX36** Olympic curved V-bar 50mm 125cm  
Length: 1200mm | Handle Ø30mm | Sleeve Ø50mm | Weight: 8 KG  
Maximum load: 315 KG | Bearing type: Needle | Brushed steel finishing



**LMX35** Multi purpose bar 50mm 90cm  
Length: 900mm | Handle Ø30mm | Sleeve Ø50mm | Weight: 10 KG  
Maximum load: 315 KG | Bearing type: Needle | Brushed steel finishing

## Specialty bars



**LMX32.01** Olympic bar 50mm 180cm (aluminum) 10Kg  
 Length: 1800mm | Handle Ø30mm | Sleeve Ø50mm | Weight: 10 KG  
 Maximum load: 40 KG | Aluminum | Bearing type: Bushing  
 Technique only



**LMX32.03** Crossmaxx® Aluminum technique bar 3kg  
 Length: 1500mm | Handle Ø28mm | Weight: 3 KG | Aluminum



**LMX37 PRO** Olympic PRO hex bar  
 Handle: multiple grips, different diameter | Sleeve Ø50mm  
 Weight: 25 KG | Maximum load: 400 KG | Colour: silver



**LMX39** Crossmaxx® Farmer's walk set (black)  
 Handle Ø30mm | Sleeve Ø50mm | Weight: 20 KG, per piece  
 Maximum load per handle: 300 KG | Colour: black



**LMX39.2** Crossmaxx® Olympic Swiss bar PRO  
 Length: 2200mm | Handle Ø30mm | Sleeve Ø50mm



**LMX32.02** Olympic bar 50mm 180cm (aluminum) 5kg  
 Length: 1800mm | Handle Ø30mm | Sleeve Ø50mm | Weight: 5 KG  
 Maximum load: 40 KG | Aluminum | Bearing type: Bushing  
 Technique only



**LMX37** Olympic hex bar  
 Length: 1400mm | Handle Ø30mm | Sleeve Ø50mm | Weight: 20,5 KG  
 Maximum load: 315 KG | Brushed steel finishing



**LMX41** Olympic safety squat bar  
 Length: 2200mm | Handle Ø30mm | Sleeve Ø50mm | Maximum load: 450 KG



**LMX39.1** Crossmaxx® Strongman Log bar  
 Weight: 45 KG | 4 handles | Colour: black



**LMX40** Crossmaxx® Axle bar with collars  
 Length: 2200mm | Handle Ø50mm | Sleeve Ø50mm | Weight: 20 KG  
 Maximum load: 675 KG | Colour: black



**LMX46** Bar 30mm 220cm

Length: 2200mm | Handle Ø30mm | Weight: 13 KG | Steel

**LMX47** Bar 30mm 180cm

Length: 1800mm | Handle Ø30mm | Weight: 10 KG | Steel

**LMX48** Bar 30mm 160cm

Length: 1600mm | Handle Ø30mm | Weight: 8 KG | Steel



**LMX45.01** Curled V-bar 30mm

Length: 1250mm | Handle Ø30mm | Weight: 6 KG | Steel



**LMX11** Dumbbell bar set 30mm (rotating)

Length: 360mm | Handle Ø30mm | Handle length: 120mm | Per set

## Bars (Ø30mm)



**LMX49** EZ bar 30mm

Length: 1200mm | Handle Ø30mm | Weight: 8 KG | Steel



**LMX45** Multi purpose bar 30mm

Length: 850mm | Handle Ø30mm | Weight: 8 KG | Steel



# ACCESSORIES

Cable attachments | Fitness accessories | Training accessories



## Cable attachments



**LMX01** Lat bar  
Length: 950mm | PU grip



**LMX03** EZ biceps/triceps bar  
Length: 750mm | PU grip



**LMX05** Triceps straight bar  
Length: 500mm | PU grip



**LMX07** Pro angled lat bar  
Length: 930mm | Handle size: 140mm | PU grip



**LMX09** Tricep rope  
Length: 700mm



**LMX02** Lat bar (large)  
Length: 1200mm | PU grip



**LMX04** Angled biceps/triceps bar  
Length: 650mm | PU grip



**LMX06** Pro lat bar  
Length: 670mm | Handle size: 140mm | PU grip



**LMX08** Tricep single rope  
Length: 370mm



**LMX10** Multi purpose handle  
Distance between handles: 380mm | PU grip



## Cable attachments



**LMX12** Tricep V-bar rotating  
Length: 440mm | PU grip



**LMX14** Cable handle  
Grip size: 130mm | PU grip



**LMX16** Rowing handle (large)  
Distance between handles: 370mm | PU grip



**LMX18** Cable handle V2  
Grip size: 130mm



**LMX13** Rowing handle  
Distance between handles: 175mm | PU grip



**LMX15.PRO** Strap handle PRO  
Grip size: 130mm | Maximum load: 40 KG | Ergonomic handle



**LMX17** Tricep V-bar  
Length: 350mm | PU grip



**LMX25** Ankle strap  
Adjustable



**LMX23** Forearm trainer  
Compatible with 30mm discs | Excl. 30mm disc



**LMX24.1** Neck support roll (rubber)  
Length: 500mm | Ø80mm



**LMX27/IMX28** Rubber grip, per meter  
Per meter | Available inner diameters: Ø25mm, Ø30mm



**LMX50.01** Body pump collar  
Ø30mm | Per set



**LMX53** Fast lock collar  
Ø50mm | Per set

## Fitness accessories



**LMX24** Neck support roll  
Length: 450mm | Velcro closing



**LMX26** Rubber grip  
Ø25mm | Closed end | Available lengths: 150mm, 200mm, 250mm, 450mm



**LMX50** Spring collar  
Ø30mm | Per set



**LMX51** Olympic spring collar  
Ø50mm | Per set



**LMX52** Olympic regular collar  
Ø50mm | Per set

### Cable

**LMX55** Per meter | 4 x 5,5mm | 7x19

**LMX55\_100** 100 meter bundle | 4 x 5,5mm | 7x19

**LMX55\_250** 250 meter bundle | 4 x 5,5mm | 7x19

## Fitness accessories



**LMX56** Cable fixer  
With eye



**LMX58** Weight stack pin  
Pin Ø10mm | Length pin: 110mm



**LMX63** Pulley double bearing  
Ø125mm



**LMX66** Number sticker  
Per sticker



**LMX69** Dumbbellsaddle  
Compatible with LMX1012 dumbbell rack



**LMX57** Snaphook  
Length 90mm



Magnetic weight stack pin

**LMX59** Pin Ø8mm | Length pin: 82mm | With coil leash

**LMX60** Pin Ø10mm | Length pin: 110mm | With coil leash



**LMX64** Pulley  
Ø108mm



**LMX67.20** Footroll  
Dimensions: L: 200mm x W: 100mm | Inner Ø25mm



**LMX67.25** Footroll  
Dimensions: L: 250mm x W: 140mm | Inner Ø25mm

Power chain set

Per set | Including collars

**LMX68.08** 8 KG per chain

**LMX68.12** 12 KG per chain

**LMX68.16** 16 KG per chain



## Training accessories



**LMX1810** Crossmaxx® Weightlifting belt  
Leather | Colour: black | Available sizes: S, M, L, XL



**LMX1818** Crossmaxx® Wrist wrap  
Per set



**LMX70** Crossmaxx® Dip belt  
Colour: black



**LMX1820** Hanging ab strap  
Per set | Colour: black



**LMX1815** Crossmaxx® Lifting straps  
Per set



**LMX1806** Crossmaxx® Mobility band roll  
Length: 7ft



**LMX71** Head harness  
Colour: black



**LMX1821** Harness for sled  
Colour: black



**LMX1822** Crossmaxx® Cannonball grip  
Per set | Colour: black

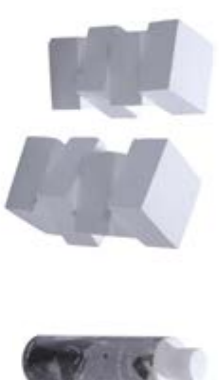

**LMX1805** Gym chalk (magnesium)  
8pcs per box

**LMX1807** Liquid chalk  
200ml



# FUNCTIONAL TRAINING & GROUPTFITNESS



**LMX1100XX Gymball**  
Anti burst, tested up to 250KG | Available in the following sizes: Ø55cm (purple or silver), Ø65cm (orange or silver), Ø75cm (green or silver)



**LMX1102 Gymball base**  
Ø50cm | Colour red



**LMX1110 Adjustable ankle/ weight set PRO (2x1,25 kg)**  
Velcro closing | adjustable weight



**LMX1116 Mini band**  
Pack of 10pcs | Available in the following levels: level 1 (yellow), level 2 (green), level 3 (orange), level 4 (blue)



**LMX1115 Flex band**  
Length: 12m | Available in the following levels: light (yellow), medium (purple), heavy (blue)



**LMX1101 Peanutball**  
Anti burst, tested up to 250KG | Colour silver



**LMX1129 Body pump set dia. 30mm (coloured)**  
This set contains a body pump bar, weights (2x 1,25 KG, 2x 2,5 KG, 2x 5 KG) & collars



**LMX1131 Body pump bar 30mm 1400mm with collar set**  
Ø30mm | Rubber grip | Weight: 2 KG | Length: 1400mm  
With spring collar set or body pump collar set



**LMX1132 Body pump disc**  
Rubber | Available in the following weights: 1,25, 2,5, 5, 10KG  
Per piece | 1 year warranty



**LMX1122 PRO step (3-level)**

Anti-slip surface | three adjustable height levels: 150, 200 and 250mm  
Dimensions: L: 900mm x W: 350mm



**LMX1133 Body pump neck support roll**

Length: 200mm



**LMX1170 Training tube**

With exchangeable canvas protection | Length: 1220mm  
Material: Latex | Available in 5 resistance levels: level 1 (yellow), level 2 (green), level 3 (orange), level 4 (blue), level 5 (purple)



**LMX1180 Crossmaxx® Resistance band**

Latex | Available levels: level 1 (red, W: 13,4mm), level 2 (green, W: 28,6mm), level 3 (orange, W: 44,5mm), level 4 (blue, W: 63,5mm), level 5 (purple, W: 82,6mm) | Length: 1040mm | Thickness: 4,5mm



**LMX1150 Vinyl dumbbellset**

Per set | Available in the following weights: 0,5, 1, 1,5, 2, 3, 4, 5 KG



**LMX1171 Power tube**

With canvas protection | Length: 1250mm | Material: Latex | Available in 4 resistance levels: level 1 (yellow), level 2 (green), level 3 (orange), level 4 (blue)



**LMX1222 Pilates/Yoga mat**

Durable honeycomb structure | With eyelets for easy storage | Dimensions: L: 1800mm x W: 600mm x H: 8mm | Available in green



**Aerobic mat**

**LMX1220**

Dimensions: L: 1400mm x W: 600mm x H: 16mm | Available in black, blue, green

**LMX1221**

Dimensions: L: 1800mm x W: 600mm x H: 16mm | Available in black, blue





**LMX1240 Slamball**

Does not bounce when dropped | Sand filling  
Available weight: 6, 8, 10, 12, 16, 20, 35, 50, 70 KG | Colour: black



**LMX1245 Crossmaxx® wall ball**

High absorption level | Rubber filling | 2 KG ball Ø250mm  
Other weights Ø350mm | Available weights: 2, 4, 6, 8, 9, 10, 12 KG



**LMX1250 Medicine ball**

Textured rubber surface | Available weights: 1, 2, 3, 4, 5 KG



**LMX1250 Double handle medicine ball**

Textured rubber surface | With ergonomic handles  
Available weights: 6, 7, 8, 9, 10 KG



**LMX1277.1 Rubber roll-out ladder**

Dimensions: L: 4500mm x W: 400mm x H: 3mm | Material: rubber



**LMX1260 Pilates ball**

Available sizes and colours: Ø20cm (blue), Ø25cm (yellow)



**LMX1260 BAG Pilates ball net**



**Speed ladder**

With bag

**LMX1270** length: 4,5m

**LMX1270.XL** Length: 9m



**SAQ resistance set**

Set contains: 1 harness, 2 resistance tubes (260mm) and 2 handles

**LMX1272.1** Level 1 (green)

**LMX1272.2** Level 2 (blue)

**LMX1272.3** Level 3 (grey)



**LMX1274 Reaction ball**

Ø70mm | Colour: red



**LMX1276 Marking cone**

Height: 150mm | Per piece | Colour: orange



**LMX1282 Crossmaxx® 4 digit timer**

Clock display 12hour / 24hour | Count up (0:00 to 99:59) can be customised | Count down (0:00 to 99:59) - can be customised  
Custom programmable intervals | Loud beep | Remote controlled



**Battle rope**

Length: 15m | Material: PP | Colour: black

**LMX1285.1** Ø1" (2,5cm)

**LMX1285.2** Ø1,5" (3,7cm)

**LMX1285.3** Ø2" (5cm)



**LMX1275 Cones**

25 cones per set | With rack for easy storage | Colour: orange



**LMX1271 Agility hurdle set**

Set contains 4 hurdles | Twist hurdle to adjust height from 170mm to 300mm | Colour: green



**LMX1283 Crossmaxx® 6 digit timer**

Clock display 12hour / 24hour | Count up (0:00 to 99:59) - can be customised | Count down (0:00 to 99:59) - can be customised  
Custom programmable intervals | Interval rounds shown | Loud beep  
Remote controlled



**Battle rope with sleeve**

Length: 12m | With canvas cover

**LMX1287.1** Ø1,5" (3,7cm)

**LMX1287.2** Ø2" (5cm)



**LMX1290** **Leather jump rope**  
Length: 270cm | With bearing



**LMX1291** **Crossmaxx® Speed rope**  
With bearing | Adjustable length



**LMX1293** **Chromed handle speed rope**  
With bearing | Adjustable length



**Soft plyo box**

Soft anti-slip surface | Boxes can be stacked and secured with Velcro strips | Dimensions: L: 900mm X W: 700mm

**LMX1297.30** Height: 300mm (orange)

**LMX1297.45** Height: 450mm (grey)

**LMX1297.60** Height: 600mm (black)



**LMX1290.W** **Weighted jump rope**  
PVC coated steel cable | Weighted handles (can be removed)  
Adjustable length



**Functional speed rope**  
With bearing | Adjustable length

**LMX1292B** Colour: black

**LMX1292G** Colour: green



**LMX1296** **Crossmaxx® Wooden plyo box (3-level)**

Made from thick 20mm plywood | Can be used on all sides  
Dimensions: L: 760mm X W: 610mm X H: 510mm



**LMX1298** **Steel plyo box set (12", 18", 24" and 30")**

Set of 4 plyo boxes | Rubber surface | Different heights: 12", 18", 24" and 30"  
Colour: silver



**LMX1297.MULTI** **Crossmaxx® 3-in-1 Soft plyo box**

Dimensions: L: 762 X W: 610 X H: 508 mm | Available colour: red or grey





**LMX0605 PRO abroller**  
Weight: 12 KG | Colour: silver



**LMX1402 3-way push-up twister**  
Product has multiple functions: traditional push up, rotating push up and twister | Per set



**LMX1401 Ab wheel**



**LMX1403 Push-up bar**  
Anti-slip | Per set



**LMX1906 Crossmaxx® Ab mat PRO**  
Durable material | Anti-slip bottom | Colour: black



**LMX1450 Gravity boots**  
Can be hooked to bars up to Ø30mm | With comfortable padding  
With safety lock



**LMX1404 Swing bar 160cm**  
Length: 1600mm | Colour: red



**LMX1406 Ab wheel PRO**





**LMX1501 PT4Pro suspension trainer kit**

This kit contains: 2 ergonomic handles, 1 anchor line, 2 adjustable base lines, 1 travel bag, 1 manual with clear instructions



**LMX1501R PT4Pro training ring set (black)**

Add-on for the PT4Pro® suspension trainer



**LMX1503 Wooden training ring set**

Set contains: 2 wooden rings (1,25"), 2 high quality adjustable straps with marking



**LMX1501P PT4Pro rotation pulley (black)**

Add-on for the PT4Pro® suspension trainer | Without handles



**LMX1502 Training ring set**

Set contains: 2 ABS rings, 2 high quality adjustable straps with marking



**Challenge bag**

With strong nylon straps | 5 ergonomic grips

**LMX1550.06** 6 KG (orange)

**LMX1550.08** 8 KG (yellow)

**LMX1550.10** 10 KG (red)

**LMX1550.12** 12 KG (blue)

**LMX1550.16** 16 KG (green)

**LMX1550.20** 20 KG (black)



**Crossmaxx® Sandbag**

With strong nylon straps | 7 ergonomic grips | Each bag has 2 inner bags that can be filled to the desired weight

**LMX1551S** Small

**LMX1551M** Medium

**LMX1551L** Large



**LMX1605 Air stability disc**

Ø330mm | Colour: yellow



**LMX1614 Performance roller**

Ø135mm | Length: 330mm | Colour: blue, black



**LMX1613 Grid roller PRO**

Ø130mm | Length: 360mm | Colour: dark blue



**Balance dome PRO**

Ø590mm

**LMX1600.1** Height: 240mm (orange)

**LMX1600.2** Height: 210mm (blue)



**LMX1610 EVA foam roller**

Eco friendly EVA foam material | Ø150mm | Length: 900mm | Colour: blue



**LMX1612 Performance roller XL**

Ø135mm | Length: 610mm | Colour: black



**LMX1900 Weight vest PRO**

One size fits all | Maximum weight: 10 KG | Weight can be adjusted



**LMX1299 Crossmaxx® Wooden jerk block set**

Full set | Set contains: 4 blocks height 15cm, 2 blocks height 30cm, 2 blocks height 38cm | High quality plywood



**LMX1026 Double core trainer**

Suitable for all Ø50mm bars | With handles | Weight: 25 KG  
Colour: silver



**LMX1023 Crossmaxx® Power sled**

Harness included | Dimensions: L: 960mm x W: 880mm x H: 1050mm  
Sleeves suitable for all Ø50mm weight plates | Weight: 50 KG  
Colour: black



**LMX1019 Crossmaxx® Post landmine**

To be used with Ø50mm weight plate | Suitable for all Ø50mm bars  
Colour: black



**LMX1022 Total core trainer with handle**

Suitable for all Ø50mm bars | With handle | Weight: 27 KG | Colour: black



**LMX1029 Crossmaxx® Total core trainer handle**

Suitable for all Ø50mm bars | Brushed steel finishing



**LMX1024 Power sled**

Harness included | Dimensions: L: 1000mm x W: 730mm x H: 830mm  
Sleeves suitable for all Ø50mm weight plates | Weight: 27 KG | Colour: silver



**LMX1405 Equalizer set**

Height: 700mm | Colour: silver



**LMX1701 Crossmaxx® Parallettes**

Dimensions: L: 580mm x W: 350mm x H: 300mm | Handle Ø30mm  
Per set | Colour: black



**LMX1703 Crossmaxx® Parallettes V2**

Dimensions: L: 450mm x W: 325mm x H: 145mm | Handle Ø30mm  
Per set | Colour: black



**LMX1028 Crossmaxx® Sled compact**

Belt included | Sleeves suitable for all Ø50mm weight plates  
Colour: black



# RACKS & BENCHES

Free weight racks | Functional training & groupfitness racks | Benches



## Free weight racks

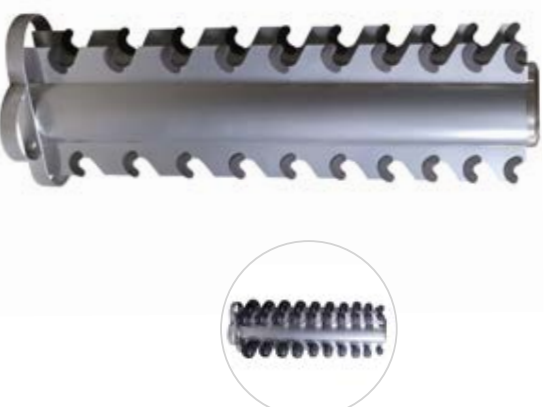

**Dumbbell rack with 2 tiers**

With dumbbells/saddles | Easily expandable | Available colours: silver or black | Without dumbbells | Suitable for LMX72 PU dumbbells,

LMX79 Fixed dumbbells, LMX75 Dumbbells, LMX81 Hexagon dumbbells

**LMX1012.5 - 5 sets** Dimensions: L: 1200mm x W: 600mm x H: 800mm

**LMX1012.6 - 6 sets** Dimensions: L: 1450mm x W: 600mm x H: 800mm

**LMX1012.10 - 10 sets** Dimensions: L: 2400mm x W: 600mm x H: 800mm

**LMX1012.12 - 12 sets** Dimensions: L: 2900mm x W: 600mm x H: 800mm

**LMX1012.15 - 15 sets** Dimensions: L: 3600mm x W: 600mm x H: 800mm

**LMX1012.18 - 18 sets** Dimensions: L: 4350mm x W: 600mm x H: 800mm

**LMX1012.20 - 20 sets** Dimensions: L: 4800mm x W: 600mm x H: 800mm

**LMX82 Dumbbell tower**

Dimensions: L: 550 mm x W: 450mm x H: 1350mm | Suitable for LMX79 Fixed dumbbells and LMX80 Chrome dumbbells



**LMX94 Lifemaxx® PU dumbbell tower**

Dimensions: L: 720 x W: 480 x H: 1600mm | Suitable for 10 sets of dumbbells (LMX72 series) | Fillable with water or sand for even more stability | Without dumbbells | Colour: black



**LMX1013 Vertical dumbbell rack for fixed dumbbells**

Dimensions: L: 800mm x W: 1050mm x H: 1480mm | Suitable for LMX79 Fixed dumbbells 1 - 10 KG with 1 KG increment & 12 - 20 KG with 2 KG increment | Colour: silver

## Free weight racks



**LMX1020** Barbell rack 10pcs

For 10 barbells | Dimensions L: 800mm x W: 1000mm x H: 1650mm  
Suitable for all LMX barbells | Colour: silver



**LMX1030** Weightplate rack

Dimensions: L: 1100mm x W: 750mm x H: 1400mm  
Suitable for all LMX Ø50mm discs | Colour: silver or black



**LMX1021** Barbell rack 5pcs

For 5 barbells | Dimensions L: 800mm x W: 1000mm x H: 1650mm  
Suitable for all LMX barbells | Colour: silver



**LMX1031** Crossmaxx® Bumper plate rack

Colour: black



**LMX1032** Crossmaxx® Bumper plate stacker on wheels

Height of pin: 700mm | Colour: black



**LMX1027** Crossmaxx® Wall mounted bar rack

For 6 bars | With PVC lining to protect your bars | Colour: black



**LMX1145** Crossmaxx® Kettlebell rack

Dimensions: L: 1200mm x W: 650mm x H: 760mm | Colour: black



**LMX1025** Vertical bar rack

For 5 bars | Available for Ø30mm bars (LMX1025-30) and Ø50mm bars (LMX1025-50) | Dimensions: L: 500mm x W: 500mm x H: 250mm  
Colour: silver



**LMX1033** Crossmaxx® 9 bar holder

For 9 bars | Suitable for Ø50mm bars | Dimensions: L: 500mm x W: 500mm x H: 300mm | Colour: black



**LMX1146** Kettlebell rack

Dimensions: L: 1400mm x W: 550mm x H: 630mm | Colour: silver

## Free weight racks



**LMX1147 Aerobic kettlebell rack. For 11 kettlebells**  
 Suitable for 11 aerobic kettlebells (Code: LMX91)  
 Dimensions: L: 1100mm x W: 650mm x H: 820mm | Colour: silver



**LMX1041 Accessory tower**  
 Ideal storage for all cable attachments | Dimensions:  
 L: 650mm x W: 650mm x H: 1000mm | Without accessories



**LMX1302 Heavy duty squat stand set**  
 Adjustable height from 900mm up to 1560mm | Adjustable width:  
 free standing or connected with connecting bar | Weight: 60 KG  
 Colour: silver



**LMX1301 Squat rack**  
 With Olympic weight plate storage pins | Dimensions:  
 L: 1720mm x W: 1260mm x H: 1860mm | Colour: silver



**LMX1740 Crossmaxx® Squat rack**  
 Dimensions: L: 1280mm x W: 1455mm x H: 1880mm  
 Adjustable spotting arms and J-hooks | Colour: black



**LMX1741 Crossmaxx® Specialty squat rack**  
 Dimensions: L: 1980mm x W: 1525mm x H: 1880mm | Adjustable  
 spotting arms and J-hooks | Storage option for all weight plates  
 Colour: black



**LMX1744 Crossmaxx® Lifting platform 240x180cm**  
 Size 2400mm x 1800mm | Bamboo wooden platform  
 Rubber tiles 30mm



## Functional training & groupfitness racks



**LMX1100** Gymball holder  
Ø300mm



**LMX1105** Gymball rack  
For 9 gymballs | Height: 1950mm | Colour: silver  
Without gymballs



**LMX1104** Gymball wall holder  
Colour: silver



**LMX1143** Body pump rack. For max. 30 sets  
Provision for max. 30 body pump sets (Code: LMX1129) With multi-directional wheels | Dimensions: L: 1140mm x W: 1100mm x H: 1440mm  
Colour: silver



**LMX1144** Body pump rack. For max. 10 sets  
Provision for max. 10 body pump sets (Code: LMX1129)  
Dimensions: L: 750mm x W: 780mm x H: 1250mm | Colour: silver



**LMX1225** Aerobic matwall rack. For 10 mats  
(steel frame)  
Suitable for 10 LMX aerobic mats | Easy wall mounting



**LMX1151** Vinyl dumbbell rack with multi dir. wheels  
Suitable for LMX1150 vinyl dumbbells | With multi directional wheels  
Dimensions: L: 900mm x W: 510mm x H: 900mm | Colour: silver  
Without dumbbells



**Aerobic mat rack**  
**LMX1226** Suitable for 30 aerobic mats of 140cm | Dimensions:  
L: 730mm x W: 600mm x H: 1600mm | Colour: silver  
**LMX1227** Suitable for 30 aerobic mats of 180cm | Dimensions:  
L: 730mm x W: 600mm x H: 2000mm | Colour: silver

## Functional training & groupfitness racks



**LMX1247** Storage cart

Dimensions: L: 1270mm x W: 620mm x H: 950mm | Without products  
Colour: silver



**LMX1248** Wallball rack: For 4 wallballs

Colour: black

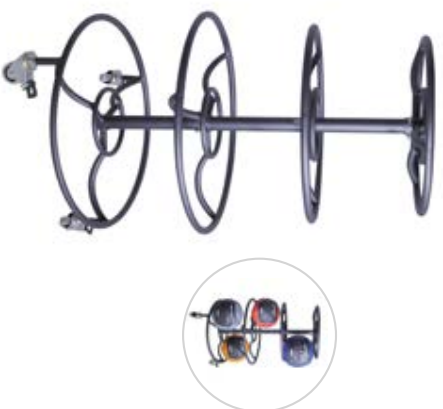

**LMX1246** Wallball rack

Suitable for storage of 12 wallballs | Colour: black



**LMX1251** Medicineball rack: For 5 medicineballs

For 5 medicineballs | Dimensions: L: 470x W: 550mm x H: 1360mm  
Colour: silver



**LMX1253** Medicineball rack: For 10 medicineballs

For 10 medicineballs | Dimensions: L: 470 x W: 900mm x H: 1360mm  
Colour: silver



**LMX1286** Wall mount

Provides a solution for battle ropes and suspension trainers  
Dimensions: L: 300mm x W: 100mm | Colour: black



**LMX1252** Medicineball rebounder

Diameter of rebounder: Ø900mm | Adjusts to 4 positions | Colour: silver



**LMX1552** Sandbag rack

Suitable for 5-10 sandbags / challenge bags | Colour: silver

## Functional training & groupfitness racks



### LMX1575 Multi challenge rack (silver)

With multi directional wheels | Storage for 10 bags, 10 balls and 10 balance domes | Dimensions: L: 1450mm x W: 1150mm x H: 1930mm  
Colour: silver



### LMX1700 Crossmaxx® Wall mounted pull-up rack

Dimensions: L: 1250mm x W: 800mm | Grip Ø30mm | Colour: black



### LMX1576 Challenge bag rack. For 12 challenge bags

Suitable for storage of 12 challenge bags | Dimensions:  
L: 760mm x W: 790mm x H: 1450mm | Colour: silver



### LMX1702 Crossmaxx® Multi-grip pull-up rack

Dimensions: L: 1310mm x W: 600mm | Grip Ø30mm | Colour: silver



### LMX1050 Multi purpose bench

The back rest is adjustable in 8 positions, from 10 degrees decline to 80 degrees incline | Seat is adjustable in 3 positions | Dimensions:  
L: 1500x W: 800mm x H: 500mm | Colour: silver or white



### LMX1052 Olympic press bench

Two individual bar positions | With olympic weight plate storage pins  
Dimensions: L: 1580mm x W: 1750mm x H: 1220mm | Colour: silver

## Benches



### LMX1051 Flat bench

Dimensions: L: 1400mm x W: 800mm x H: 500mm | Colour: silver



### LMX1054 Olympic incline bench

Two individual bar positions | With olympic weight plate storage pins  
Dimensions: L: 1580mm x W: 1750mm x H: 1650mm | Colour: silver



## Benches



**LMX1303** Sissy squat bench  
Adjustable | Colour: silver



**LMX1743** Crossmaxx® Flat bench  
Colour: black



**LMX1742** Crossmaxx® Glute Ham Developer PRO  
Adjustable in 13 positions | Dimensions: L: 1500mm x W: 970mm x H: 105mm | Weight: 60 KG | With pins for resistance bands (LMX1180) | Colour: black



**LMX1055** Adjustable bench  
Adjustable in 7 positions | Dimensions: L: 1350mm x W: 700mm  
Colour: black



# LIFEMAXX FUNCTIONAL RACK

## Racks & Accessories

The Lifemaxx Functional Rack is a multi-functional piece of equipment that can be deployed in many different ways, creating an inspiring fitness experience. This one single piece of equipment is suitable for athletes of all levels and can be used for individual training, PT sessions and small group workouts. The Lifemaxx Functional Rack capitalizes on the latest trends and developments relating to functional training.

There is a Functional Rack for every space. The following models are available: Functional Rack Large, Functional Rack Small or Functional Wall Rack, a wall-mounted model. The Large and Small models can be customized with many different options and accessories.

Also available: FANMATIC, a complete 12-month training program to implement functional small group workouts in your facility.



### LMX1855 Functional Rack Large

Dimensions: 493 x 220 x 262 cm (LxWxH)

Colour options:

**LMX1855.1** Dark grey frame/Dark grey top

**LMX1855.2** Orange frame/Orange top

**LMX1855.3** Dark grey frame/Orange top

**LMX1855.4** Orange frame/Dark grey top

Anchors for battle rope  
or resistance trainers



### LMX1850 Functional Rack Small

Dimensions: 253 x 220 x 262 cm (LxWxH)

Colour options:

**LMX1850.1** Dark grey frame/Dark grey top

**LMX1850.2** Orange frame/Orange top

**LMX1850.3** Dark grey frame/Orange top

**LMX1850.4** Orange frame/Dark grey top



Storage options



Hard-chrome coating  
on all pull-up positions

## Full option model Functional Rack Large & Small

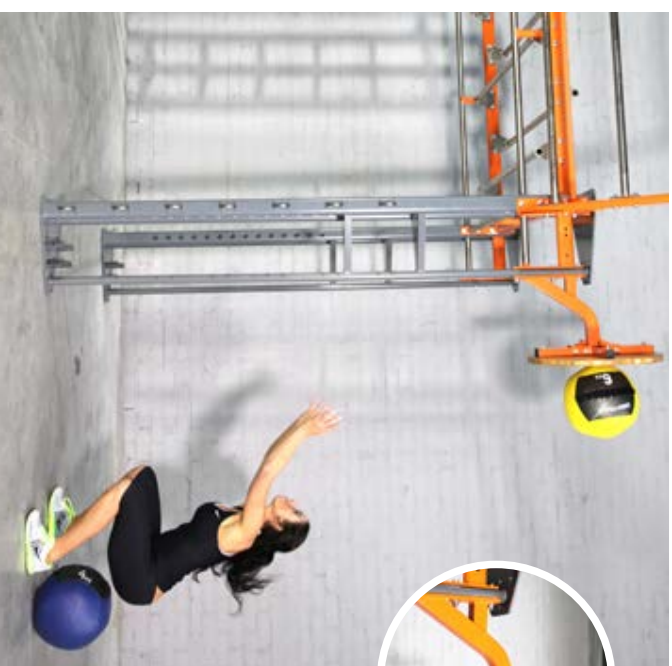

### Wallball target board

Dimensions: 253 x 220 x 262 cm (LxWxH)

Colour options:

**LMX1860.O** Wallball Target board, Orange

**LMX1861.G** Wallball Target board, Grey

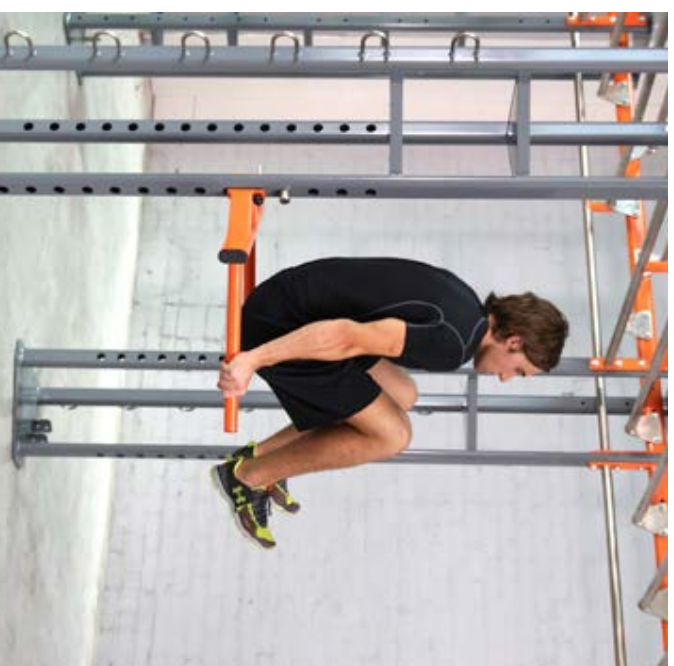

### Dip station

Dimensions: 253 x 220 x 262 cm (LxWxH)

Colour options:

**LMX1861.O** Dip Station, Orange

**LMX1861.G** Dip Station, Grey

## Accessories Functional Rack Large & Small



### Plyo platform

Dimensions: 253 x 220 x 262 cm (LxWxH)

Colour options:

**LMX1862O** Plyo Platform, Orange

**LMX1862G** Plyo Platform, Grey



### Total core trainer

Dimensions: 253 x 220 x 262 cm (LxWxH)

Colour options:

**LMX1863O** Total Core Trainer, Orange

**LMX1863G** Total Core Trainer, Grey



\* Boxing bag excluded

### Boxing bag arm

**LMX1864O** Boxing Bag Arm, Orange

**LMX1864G** Boxing Bag Arm, Grey

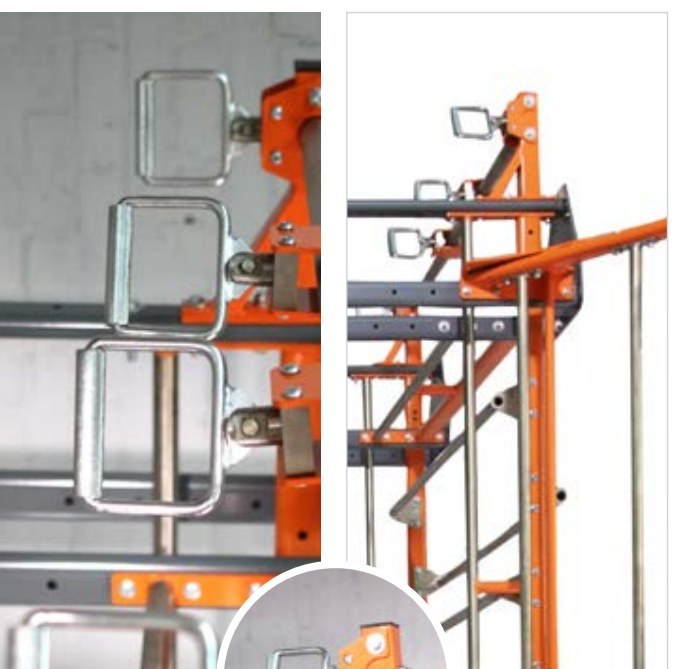

### Pull Up on sliding rails

**LMX1865O** Pull Up on sliding rails, Orange

**LMX1865G** Pull Up on sliding rails, Grey

## Accessories Functional Rack Large & Small



### Squat rack attachment

**LMX1866O** Squat rack attachment, Orange

**LMX1866G** Squat rack attachment, Grey  
This accessory makes the length of your Functional Rack 50cm longer.



### Olympic bar storage

**LMX1868O** Olympic bar storage, Orange

**LMX1868G** Olympic bar storage, Grey



### Monkey wing

**LMX1867O** Monkey Wing, Orange

**LMX1867G** Monkey Wing, Grey  
This accessory makes the total height of your Functional Rack 330cm.

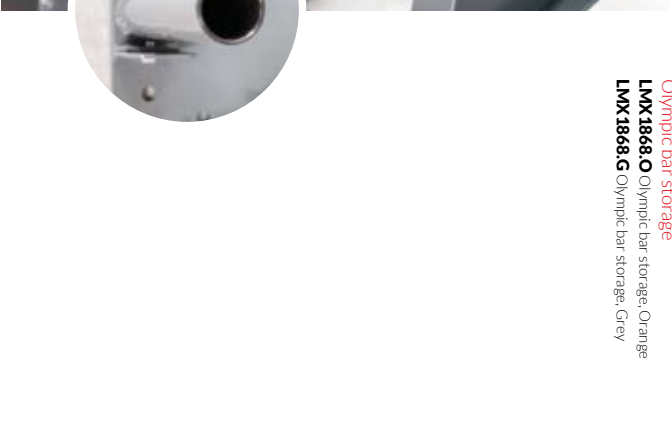

### Adjustable pulley

**LMX1869G** Adjustable Pulley, Grey

100 KG weight stack | Adjustable in 13 positions  
Dual handle | This accessory makes the length or width of your Functional Rack 75cm longer/wide



## Functional Wall Rack



### Functional Wall Rack

- LMX1880.1** Functional wall rack, Orange frame/Orange top
  - LMX1880.2** Functional wall rack, Grey frame/Grey top
  - LMX1880.3** Functional wall rack, Grey frame/Orange top
  - LMX1880.4** Functional wall rack, Orange frame/Grey top
- Width: 161cm | Height: 329cm | 2 Olympic bar holders  
2 Total Core Trainers | Anchors for battle rope and resistance trainers

# FANATIC

The FANATIC training program is a monthly changing, license free, 30 minute functional training program for your Lifemaxx Functional Rack. It is developed to offer the participants a fun, challenging and effective training, under the guidance of a good instructor. The training program consist of 100% functional movements, movements that are made in everyday life. The FANATIC workouts ensure that the participants are always challenged at their own level and will make the training a place of joy and experience.

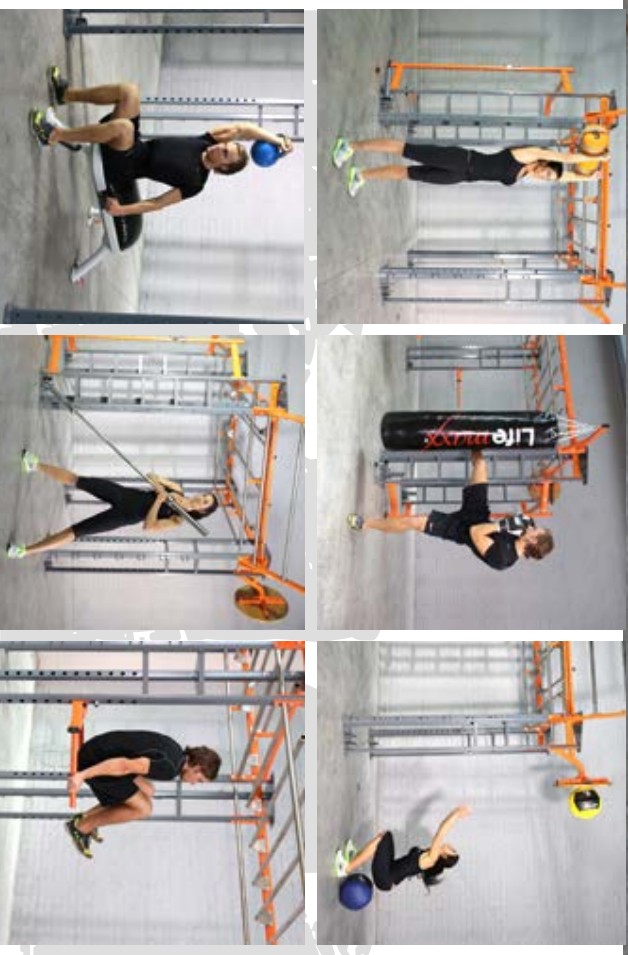

## Floors



**LMX1345** Crossmaxx® 20mm jigsaw tile

Dimensions: L: 500mm x W: 500mm x H: 20mm | Colour: black, blue, grey or green



**LMX1346** Crossmaxx® 20mm jigsaw edge

Dimensions: L: 500mm x W: 250mm x H: 20mm | Colour: black, blue, grey or green



**LMX1347** Crossmaxx® 20mm jigsaw corner

Dimensions: L: 250mm x W: 250mm x H: 20mm | Colour: black, blue, grey or green



**LMX1350** Rubber floor mat

Made of high density rubber | Dimensions: L: 500mm x W: 500mm x H: 10mm | Colour: black



**LMX1351** Rubber floor edge

Made of high density rubber | Dimensions: L: 500mm x W: 160mm x H: 10mm | Sloping | Colour: black



**LMX1356** Absorbing rubber floor edge

Dimensions: L: 500mm x W: 200mm x H: 15mm | Sloping | Colour: black



**LMX1352** Rubber floor corner

Made of high density rubber | Dimensions: L: 160mm x W: 160mm x H: 10mm | Sloping | Colour: black



**LMX1355** Absorbing rubber floor tile

Dimensions: L: 1000mm x W: 1000mm x H: 15mm | Colour: black



**LMX1357** Absorbing rubber floor corner

Dimensions: L: 200mm x W: 200mm x H: 15mm | Sloping | Colour: black

# CROSSMAXX® Strength

Olympic bars | Bumper plates | Collars & chains | Dumbbells

Kettlebells | Jerk blocks | Platform | Core training



## Olympic bars



**LMX30** Olympic competition bar  
Length: 2200mm | Handle Ø28mm | Sleeve Ø50mm  
Weight: 20 KG | Maximum load: 675 KG | Spring steel  
Bearing type: Needle | Brushed steel finishing | PSI: 210000



**LMX38** Olympic competition women's bar  
Length: 2010mm | Handle Ø25mm | Sleeve Ø50mm  
Weight: 15 KG | Maximum load: 475 KG | Spring steel  
Bearing type: Needle | Brushed steel finishing | PSI: 210000



**LMX43** Crossmaxx® Olympic compact competition bar  
Length: 1780mm | Handle Ø28,5mm | Sleeve Ø50mm | Weight: 16 KG  
Maximum load: 2000LB | Spring steel | Bearing type: Needle - 4 per sleeve | Black oxide and hard chrome finishing | PSI: 205000



**LMX32.02** Olympic bar 50mm 180cm (aluminum) 5kg  
Length: 1800mm | Handle Ø30mm | Sleeve Ø50mm | Weight: 5 KG  
Maximum load: 40 KG | Aluminum | Bearing type: Bushing



**LMX37** Olympic hex bar  
Length: 1400mm | Handle Ø30mm | Sleeve Ø50mm | Weight: 20,5 KG  
Maximum load: 315 KG | Brushed steel finishing



**LMX34** Crossmaxx® Olympic competition bar  
(black/chrome)  
Length: 2200mm | Handle Ø28mm | Sleeve Ø50mm | Weight: 20 KG  
Maximum load: 2000LB | Spring steel | Bearing type: Needle - 4 per sleeve | Black oxide and hard chrome finishing | PSI: 205000



**LMX44** Crossmaxx® Olympic competition women's bar  
(black/chrome)  
Length: 2010mm | Handle Ø25mm | Sleeve Ø50mm | Weight: 15 KG  
Maximum load: 1200LB | Spring steel | Bearing type: Needle - 4 per sleeve | Black oxide and hard chrome finishing | PSI: 205000



**LMX32.01** Olympic bar 50mm 180cm (aluminum) 10kg  
Length: 1800mm | Handle Ø30mm | Sleeve Ø50mm | Weight: 10 KG  
Maximum load: 40 KG | Aluminum | Bearing type: Bushing



**LMX32.03** Crossmaxx® Aluminum technique bar 3kg  
Length: 1500mm | Handle Ø28mm | Weight: 3 KG | Aluminum



**LMX37 PRO** Olympic PRO hex bar  
Handle: multiple grips, different diameter | Sleeve Ø50mm  
Weight: 25 KG | Maximum load: 400 KG | Colour: silver



## Olympic bars



**LMX39** Crossmaxx® Farmer's walk set

Handle: Ø30mm | Sleeve: Ø50mm | Weight: 20 KG, per piece  
Maximum load per handle: 300 KG | Colour: black



**LMX39.2** Crossmaxx® Olympic Swiss bar PRO

Length: 2200mm | Handle: Ø30mm | Sleeve: Ø50mm



**LMX41** Olympic safety squat bar

Length: 2200mm | Handle: Ø30mm | Sleeve: Ø50mm | Maximum load: 450 KG



**LMX39.1** Crossmaxx® Strongman Log bar

Weight: 45 KG | 4 handles | Colour: black



**LMX40** Crossmaxx® Axle bar with collars

Length: 2200mm | Handle: Ø50mm | Sleeve: Ø50mm | Weight: 20 KG  
Maximum load: 675 KG | Colour: black

## Jerk blocks



**LMX1299** Crossmaxx® Wooden jerk block set

Full set | Set contains: 4 blocks height: 15cm, 2 blocks height: 30cm,  
2 blocks height: 38cm | High quality plywood



## Platform



**LMX1744** Crossmaxx® Lifting platform 240X180cm

Size: 2400mm x 1800mm | Bamboo wooden platform | Rubber tiles  
30mm



## Bumper plates



**LMX83C Crossmaxx® Competition bumper plate (coloured)**  
 Ø50mm | Rubber | Available in the following weights: 10, 15, 20, 25 KG  
 Stainless steel inserts | Per piece | 1 year warranty



**LMX83 Crossmaxx® Fractional plate**  
 Ø50mm | Rubber | Available in the following weights: 0.5, 1, 1.5, 2, 2.5 KG | Per piece | 1 year warranty



**LMX87 Crossmaxx® Bumper plate**  
 Ø50mm | Rubber | Available in the following weights: 5, 10, 15, 20, 25 KG | Stainless steel inserts | Per piece | 1 year warranty



**LMX85 Crossmaxx® Competition bumper plate (black)**  
 Ø50mm | Rubber | Available in the following weights: 5, 10, 15, 20, 25 KG  
 Stainless steel inserts | Per piece | 1 year warranty



**LMX87.025 Crossmaxx® Technique plate**  
 Ø50mm | PVC | Available in 2.5 KG | Per piece | Plate Ø 450mm



**LMX51 Olympic spring collar**  
 Ø50mm | Per set



**LMX53 Fast lock collar**  
 Ø50mm | Per set

## Collars & Chains



**Power chain set**  
 Per set | Including collars  
**LMX68.08** 8 KG per chain  
**LMX68.12** 12 KG per chain  
**LMX68.16** 16 KG per chain



## Dumbbells



### LMX81 Hexagon dumbbells

Rubber | Per set | 2,5 to 40 KG, 2,5 KG increment | 1 year warranty

## Kettlebells



### LMX88 Crossmaxx® Competition kettlebell

Steel | Available in the following weights: 8, 12, 16, 20, 24, 28, 32 KG  
Handle: Ø33mm | Per piece



## Core training



### LMX1019 Crossmaxx® Post landmine

To be used with Ø50mm weight plate | Suitable for all Ø50mm bars  
Colour: black



### LMX1029 Crossmaxx® Total core trainer handle

Suitable for all Ø50mm bars | Brushed steel finishing



### LMX1022 Total core trainer with handle

Suitable for all Ø50mm bars | With handle | Weight: 27 KG  
Colour: black



### LMX93 Crossmaxx® Powdercoated kettlebell

Iron | Available in the following weights: 4, 8, 12, 16, 20, 24, 28, 32, 36, 40 KG | Per piece

# CROSSMAXX® AIR BIKE PRO

## LMX1750 Crossmaxx® Air Bike PRO

Large LCD console with 8 workouts | Quick seat adjustment  
Dual steel fan | Anti-slip pedals | Wheels for easy moving  
Dimensions: L: 1230 x W: 750 x H: 1350mm | Weight: 71,5 KG  
Max user weight: 130 KG

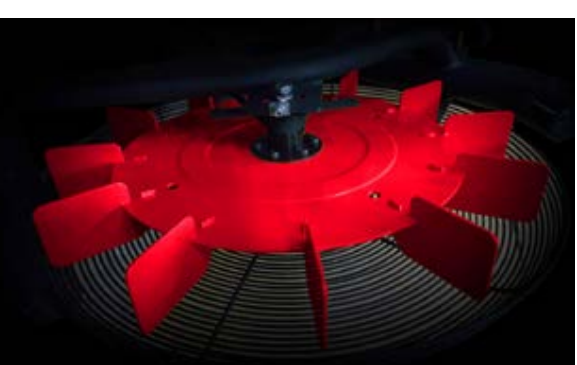

## Gymnastic & Conditioning



**LMX1502 Training ring set**  
Set contains: 2 ABS rings, 2 high quality adjustable straps with marking



**LMX1503 Wooden training ring set**  
Set contains: 2 wooden rings (125"), 2 high quality adjustable straps with marking



**Battle rope**  
Length: 15m | Material: PP | Colour: black  
**LMX1285.1** Ø1" (2,5cm)  
**LMX1285.2** Ø1,5" (3,7cm)  
**LMX1285.3** Ø2" (5cm)



**Battle rope with sleeve**  
Length: 12m | With canvas cover  
**LMX1287.1** Ø1,5" (3,7cm)  
**LMX1287.2** Ø2" (5cm)



**LMX1291 Crossmaxx® Speed rope**  
With bearing | Adjustable length



**LMX1240 Slamball**  
Does not bounce when dropped | Sand filling  
Available weights: 6, 8, 10, 12, 16, 20, 35, 50, 70 KG | Colour: black



**LMX1245 Crossmaxx® wall ball**  
High absorption level | Rubber filling | 2 KG ball Ø250mm  
Other weights Ø350mm | Available weights: 2, 4, 6, 8, 9, 10, 12 KG

# CROSSMAXX® Gymnastic & Conditioning



## Gymnastic & Conditioning



### Soft plyo box

Soft anti-slip surface | Boxes can be stacked and secured with Velcro strips | Dimensions: L: 900mm x W: 700mm

**LMX1297\_30** Height: 300mm (orange)

**LMX1297\_45** Height: 450mm (grey)

**LMX1297\_60** Height: 600mm (black)



### Crossmaxx® Sandbag

With strong nylon straps | 7 ergonomic grips | Each bag has 2 inner bags that can be filled to the desired weight

**LMX1551S** Small

**LMX1551M** Medium

**LMX1551L** Large



### LMX1297\_MULTI Crossmaxx® 3-in-1 SOFT Plyobox

Dimensions: L: 762 x W: 610 x H: 508 mm | Available colours: red or grey



### LMX1296 Crossmaxx® Wooden plyo box (3-level)

Made from thick 20mm plywood | Can be used on all sides  
Dimensions: L: 760mm x W: 610mm x H: 510mm



### LMX1298 Steel plyo box set (12", 18", 24" and 30")

Set of 4 plyo boxes | Rubber surface | Different heights: 12", 18", 24" and 30" | Colour: silver



### LMX1822 Crossmaxx® Cannonball grip

Per set | Colour: black



### LMX1028 Crossmaxx® Sled compact

Belt included | Sleeves suitable for all Ø50mm weight plates  
Colour: black



### LMX1742 Crossmaxx® Gutite Ham Developer PRO

Adjustable in 13 positions | Dimensions: L: 1500mm x W: 970mm x H: 105mm | Weight: 60 KG | With pins for resistance bands (LMX1180) | Colour: black



### LMX1406 Ab wheel PRO



### LMX1023 Crossmaxx® Power sled

Harness included | Dimensions: L: 960mm x W: 860mm x H: 1050mm  
Sleeves suitable for all Ø50mm weight plates | Weight: 50 KG  
Colour: black | Without plates



### LMX1701 Crossmaxx® Parallettes

Dimensions: L: 580mm x W: 350mm x H: 300mm | Handle Ø30mm  
Per set | Colour: black



### LMX1703 Crossmaxx® Parallettes V2

Dimensions: L: 450mm x W: 325mm x H: 165mm | Handle Ø30mm  
Per set | Colour: black

# CROSSMAXX®

## Mobility & Training accessories



## Mobility & Training accessories



**LMX1180** Crossmaxx® Resistance band  
 Latex | Available levels: level 1 (red, W: 13.4mm), level 2 (green, W: 28.6mm), level 3 (orange, W: 44.5mm), level 4 (blue, W: 63.5mm), level 5 (purple, W: 82.6mm) | Length 1040mm | Thickness: 4.5mm



**LMX1610** EVA foam roller  
 Eco friendly EVA foam material | Ø150mm | Length: 900mm  
 Colour: blue



**LMX1611** Performance roller  
 Ø135mm | Length: 330mm | Colour: blue, black



**LMX1806** Crossmaxx® Mobility band roll  
 Length: 7ft



**LMX1612** Performance roller XL  
 Ø135mm | Length: 610mm | Colour: black



**LMX1613** Grid roller PRO  
 Ø130mm | Length: 360mm | Colour: dark blue

## Mobility & Training accessories



**LMX1906** Crossmaxx® Ab mat PRO  
Durable material | Anti-slip bottom | Colour: black



**LMX1805** Gym chalk (magnesium)  
8pcs per box

**LMX1807** Liquid chalk  
200ml



**LMX1821** Harness for sled  
Colour: black



**LMX1810** Crossmaxx® Weightlifting belt  
Leather | Colour: Black | Available in size: S, M, L, XL



**LMX70** Crossmaxx® Dip belt  
Colour: black



**LMX71** Head harness  
Colour: black



**LMX1815** Crossmaxx® Lifting straps  
Per set



**LMX1818** Crossmaxx® Wrist wrap  
Per set



**LMX1283** Crossmaxx® 6 digit timer  
Clock display 12 hour / 24 hour | Count up (0:00 to 99:59) - can be customised | Count down (0:00 to 99:59) - can be customised | Custom programmable intervals | Interval rounds shown | Loud beep | Remote controlled



**LMX1282** Crossmaxx® 4 digit timer  
Clock display 12 hour / 24 hour | Count up (0:00 to 99:59) can be customised | Count down (0:00 to 99:59) - can be customised | Custom programmable intervals | Loud beep | Remote controlled





# CROSSMAXX® Racks & Benches



## Racks & benches



**LMX1030** Weightplate rack

Dimensions: L: 1100mm x W: 750mm x H: 1400mm  
Suitable for all LMX Ø950mm discs | Colour: silver or black  
Without plates



**LMX1145** Crossmaxx® Kettlebell rack

Dimensions: L: 1200mm x W: 650mm x H: 760mm | Colour: black



**LMX1033** Crossmaxx® 9 bar holder

For 9 bars | Suitable for Ø50mm bars Dimensions:  
L: 500mm x W: 500mm x H: 300mm | Colour: black



**LMX1031** Crossmaxx® Bumper plate rack

Colour: black



**LMX1032** Crossmaxx® Bumper plate stacker on wheels

Height of pin: 700mm | Colour: black



**LMX1027** Crossmaxx® Wall mounted bar rack

For 6 bars | With PVC lining to protect your bars | Colour: black

## Racks & benches



**LMX1740** Crossmaxx® Squat rack  
 Dimensions: L: 1280mm x W: 1455mm x H: 1880mm  
 Adjustable spotting arms and J-hooks | Colour: black



**LMX1741** Crossmaxx® Specialty squat rack  
 Dimensions: L: 1980mm x W: 1525mm x H: 1880mm | Adjustable spotting arms and J-hooks | Storage option for all weight plates  
 Colour: black



**LMX1248** Wallball rack. For 4 wallballs  
 Colour: black

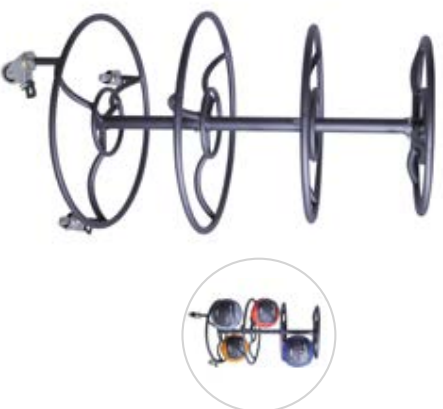

**LMX1246** Wallball rack  
 Suitable for storage of 12 wallballs | Colour: black



**LMX1700** Crossmaxx® Wall mounted pull-up rack  
 Dimensions: L: 1250mm x W: 800mm | Grip Ø30mm | Colour: black



**LMX1702** Crossmaxx® Multi-grip pull-up rack  
 Dimensions: L: 1310mm x W: 600mm | Grip Ø30mm | Colour: silver



**LMX1055** Adjustable bench  
 Adjustable in 7 positions | Dimensions: L: 1350mm x W: 700mm  
 Colour: black



**LMX1743** Crossmaxx® Flat bench  
 Colour: black

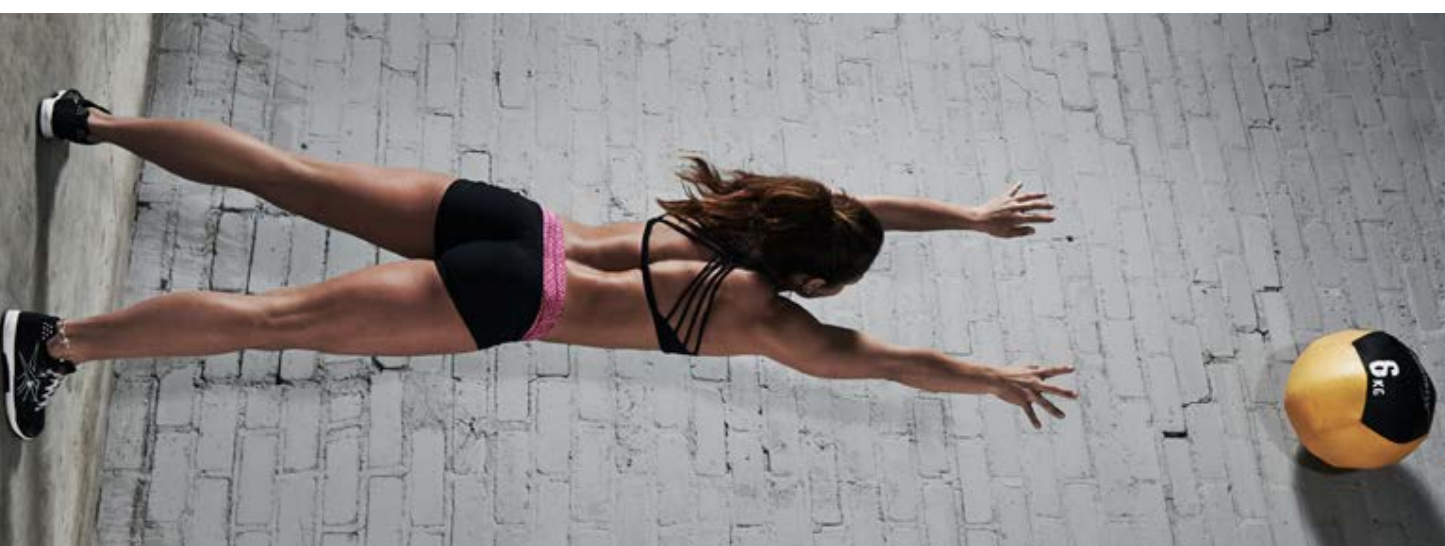



**LMX1345** Crossmaxx® 20mm jigsaw tile  
Dimensions: L: 500mm x W: 500mm x H: 20mm | Colour: black, blue, grey or green

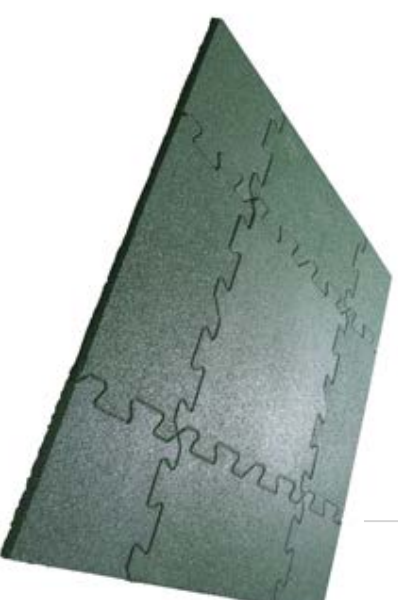

**LMX1346** Crossmaxx® 20mm jigsaw edge  
Dimensions: L: 500mm x W: 250mm x H: 20mm | Colour: black, blue, grey or green



**LMX1347** Crossmaxx® 20mm jigsaw corner  
Dimensions: L: 250mm x W: 250mm x H: 20mm | Colour: black, blue, grey or green



# CROSSMAXX® Rigs & Accessories

The Crossmaxx® Rigs are designed to fit any club or training facility. The “Build-Your-Own-Rig” enables you to select the desired components and design the rig that is best fit for you and your facility.

We offer two types of Crossmaxx® rigs: the regular model and the XL model. The difference between these types is the tube size of the upright stands. The regular model offers a strong 60x60mm tube with a 3mm wall thickness, the Crossmaxx®XL model offers a 75x75mm tube with a 3mm wall thickness. Both Crossmaxx® series are a strong and durable choice for all athletic facilities.

**Crossmaxx® Rig XL Base models**  
 Hereby a selection of Crossmaxx® XL Rigs, but anything is possible!  
 Our “Build-Your-Own-Rig” principle provides the freedom to design a Crossmaxx® XL Rig that is suitable for you!

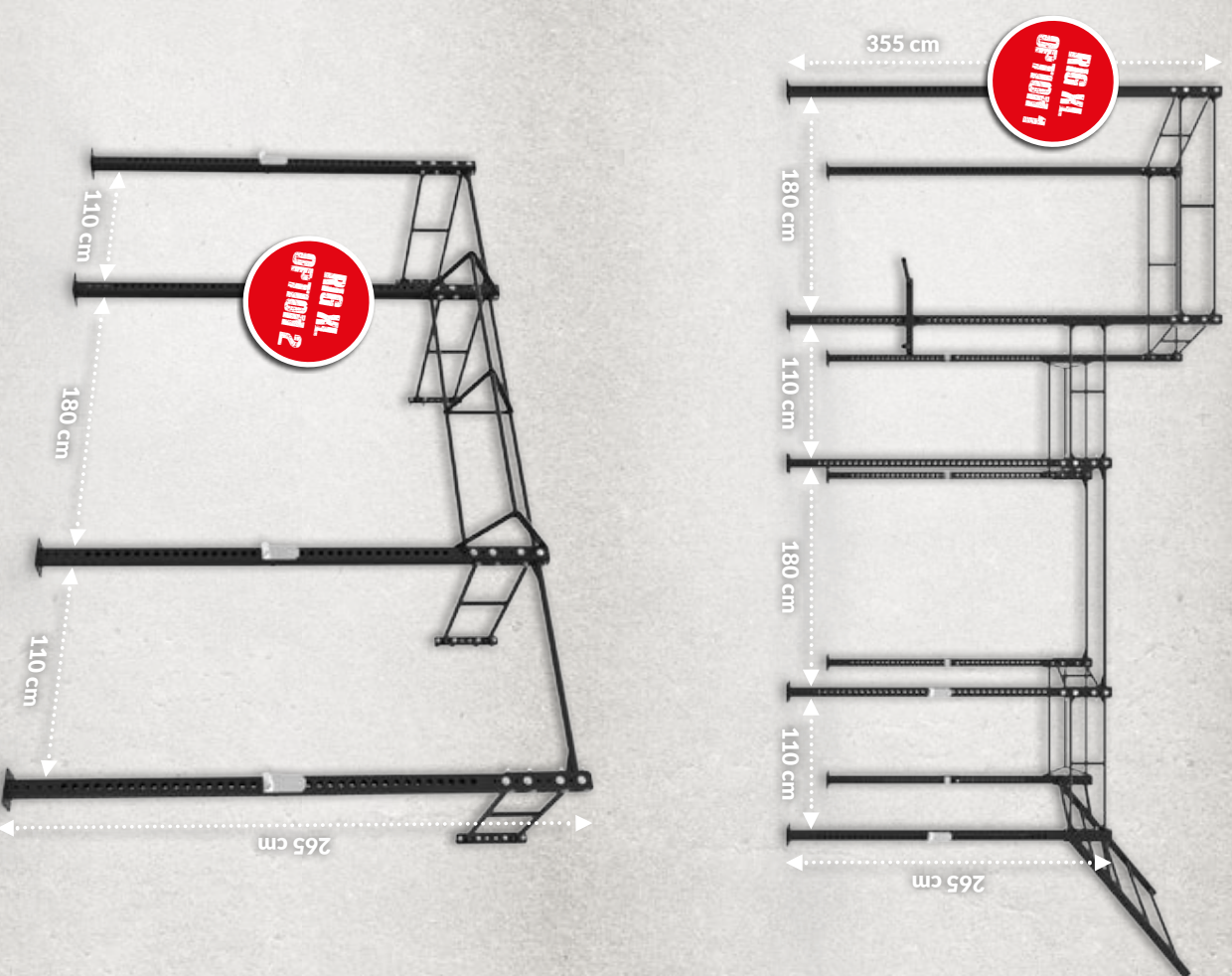



# BUILD YOUR OWN RIG

- LNK1730**  
Crossmaxx® XL upright stand  
7.5 x 7.5 x 265cm
- LNK1731**  
Crossmaxx® XL upright stand  
extender 7.5 x 7.5 x 90cm

**LNK1712**  
Crossmaxx® 110cm Standard Beam Ø 30mm



**LNK1714**  
Crossmaxx® 110cm Monkey Beam Ø 30mm



**LNK1713**  
Crossmaxx® 180cm Standard Beam Ø 30mm



**LNK1715**  
Crossmaxx® 180cm Monkey Beam Ø 30mm



**LNK1717**  
Crossmaxx® 180cm Bar  
(to be used with LNX1714 or LNX1715) Ø 30mm



**LNK1726**  
Crossmaxx® 110cm Triangle Beam Ø 30mm



**LNK1738**  
Crossmaxx® 110cm Single Beam Ø 30mm



**LNK1727**  
Crossmaxx® 180cm Triangle Beam Ø 30mm



**LNK1718**  
Crossmaxx® 180cm Single Beam Ø 30mm



**LMM1728**  
Crossmaxx® 180cm Monkey Wing



**LMM1719**  
Crossmaxx® Wall Ball Board

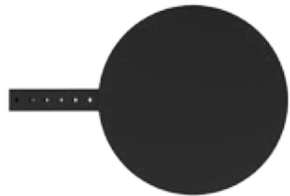

**LMM1732**  
Crossmaxx® XL Wall mount bracket



**LMM1722**  
Crossmaxx® Total Core Trainer for Rig



**LMM1718**  
Crossmaxx® Boxing Bag Arm



**LMM1737**  
Crossmaxx® XL Dip station for Rig



**LMM1733**  
Crossmaxx® XL Sporting Arm set



**LMM1734**  
Crossmaxx® XL J-Hook set



**LMM1735**  
Crossmaxx® XL Plate-Holder for Rig



**LMM1738**  
Crossmaxx® XL Batterope mount for Rig



**LMM1739**  
Crossmaxx® XL J-Hook set PRO



**LMM1729**  
Crossmaxx® Storage pin  
(suitable for rigs with Monkey beam)



**Crossmaxx® Rig Base models**  
Hereby a selection of Crossmaxx® XL Rigs, but anything is possible!  
Our "Build-Your-Own-Rig" principle provides the freedom to design  
a Crossmaxx® XL Rig that is suitable for you!

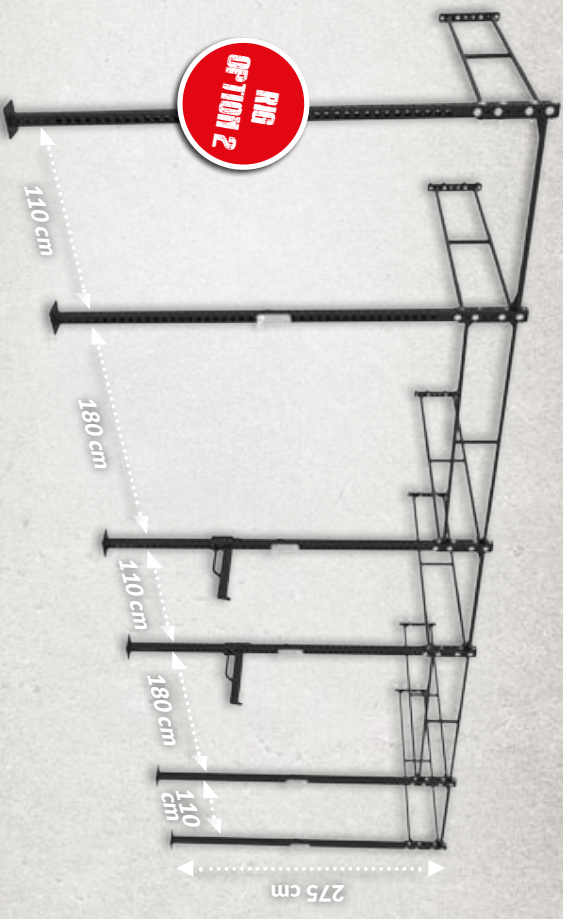
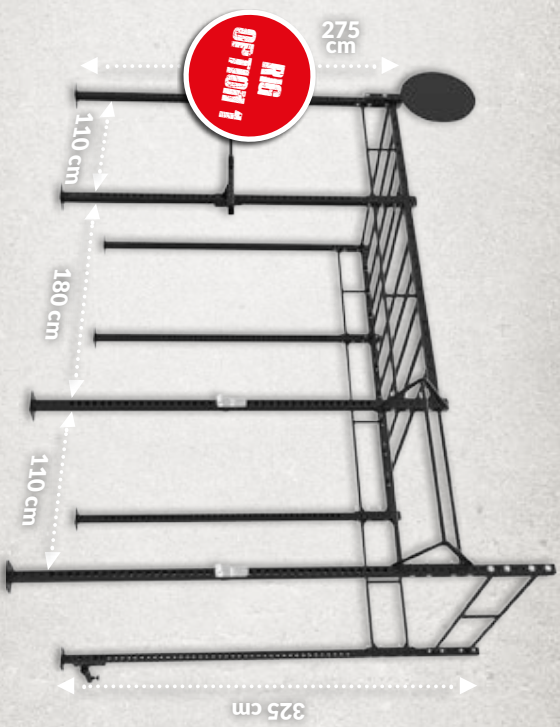



**LINK 1710**  
Crossmaxx® Upright Stand 275cm



**LINK 1711**  
Crossmaxx® Upright Stand 325cm



**LINK 1712**  
Crossmaxx® 110cm Standard Beam Ø 30mm



**LINK 1713**  
Crossmaxx® 180cm Standard Beam Ø 30mm



**LINK 1714**  
Crossmaxx® 110cm Monkey Beam Ø 30mm



**LINK 1738**  
Crossmaxx® 110cm Single Beam Ø 30mm



**LINK 1715**  
Crossmaxx® 180cm Monkey Beam Ø 30mm



**LINK 1718**  
Crossmaxx® 180cm Single Beam Ø 30mm



**LINK 1726**  
Crossmaxx® 110cm Triangle Beam Ø 30mm



**LINK 1727**  
Crossmaxx® 180cm Triangle Beam Ø 30mm



**LINK 1728**  
Crossmaxx® Monkey Wing Ø 30mm

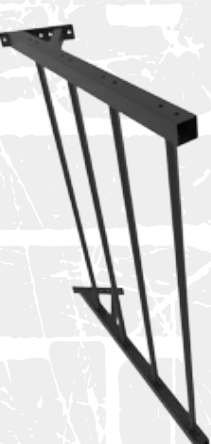

**LINK 1729**  
Crossmaxx® Storage Pin  
(suitable for rigs with Monkey beam)



**LMX1717**

Crossmaxx® 180cm Bar  
(to be used with LMX1714 or LMX1715)



**LMX1719**

Crossmaxx® Wall Ball Board

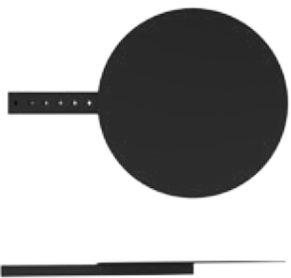

**LMX1718**

Crossmaxx® Boxing Bag Arm



**LMX1721**

Crossmaxx® Plyo Platform  
(to be used with LMX1725)

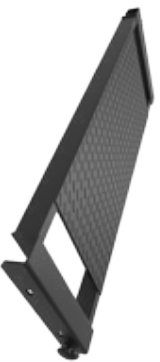

**LMX1720**

Crossmaxx® Plate Holder for Rig



**LMX1722**

Crossmaxx® Total Core Trainer for Rig



**LMX1723**

Crossmaxx® Dip station for Rig



**LMX1724**

Crossmaxx® J-Hook set



**LMX1725**

Crossmaxx® Spotting Arm set for Rig





# Ordering

Ordering Lifemaxx products can be done in several ways:

T + 31 (0) 10 415 9800

info@lifemaxx.com

www.lifemaxx.com

**When ordering please provide us with the following information:**

- Full invoice and shipping address
- VAT number
- Product codes and description of the products you wish to order
- Method of payment

**Prices:**

- All prices exclude VAT
- All prices exclude optional delivery charges
- Prices may change, please visit our website for actual prices

**Delivery:**

- We can deliver the order to you by parcel, pallet or Lifemaxx delivery service
- Delivery charges can be requested via info@lifemaxx.com

*Lifemaxx delivery service not available for orders outside The Benelux*

**Warranty:**

All Lifemaxx products are manufactured with our utmost care and craftsmanship. If any defects may arise, the following warranty regulations apply. Lifemaxx products have a standard 1 Year warranty period, with some exceptions:

- 3 years warranty on all Lifemaxx PU products.
- 6 months warranty on all cable attachments, all inflated materials, vinyl coated materials, all balls and bags.
- 3 months warranty on all elastic materials, all jump ropes and aerobic mats.

No warranty on neck support rolls and ankle straps. If problems arise within that period, Lifemaxx will repair or replace your product. We may request photographic evidence or will ask you to return the product to us for inspection. Lifemaxx will not accept responsibility for defects arising from the misuse of any goods, or problems that arise outside the control of Lifemaxx.

**Not covered by the warranty (and tips to increase the lifetime of your product!):**

- Any damage resulting from use with racks not sourced from Lifemaxx. For example rubber dumbbells should be stored on Lifemaxx dumbbell racks which feature saddles to increase the lifetime of the products.
- Damage resulting from slamming or inflating products that are not designed for this purpose. For example medicine balls are not made for slamming or inflating.
- Damage resulting from throwing or dropping products that are not designed for this purpose. For example dumbbells, discs (bumper plates excluded) and kettlebells.
- Our Crossmaxx® rigs and Functional racks must be bolted to the floor for safe use.

For our full terms and conditions, please visit our website [www.lifemaxx.com](http://www.lifemaxx.com)



# Need help?

Do you need help with the planning for your personal training zone, weight lifting area, group fitness area or the total planning of a fitness facility or box? Or do you have questions about our products? Our dedicated and experienced team is more than happy to assist you. Please contact us by e-mail or telephone. We also would be delighted to welcome you in our showroom. In our showroom you will have the possibility to try and test all our products.

Couldn't find the product you are looking for? Please visit our website [www.lifemaxx.com](http://www.lifemaxx.com) or our Facebook pages "LifemaxxFitness" or "CrossmaxxFitness" for the latest product updates or contact us.

## Have ideas?

Have you got any innovative product ideas or ideas to make the Lifemaxx assortment even better than it already is? Do not hesitate to contact us, we will be happy to listen to your ideas!

## Credits:

We would like to thank the following people and businesses for their contribution to the Lifemaxx catalogue:

- Elsie Corporate Fashion: for helping us creating this catalogue from scratch.
- Melody Liefink Photography
- Sardé Kiriyama Make-up Artist
- Our models: Belinda, Christel, Fernando, Gerson, Hanno, Nick & Shannen

Keep in touch through our Facebook and Instagram pages and read about our latest updates, innovations, events and client experiences.



/lifemaxxfitness  
/Crossmaxxfitness



/lifemaxxfitness



Partner for Croatia:

Star Fitness d.o.o.

Nova Ves 17 | Centar Kaptol | Zagreb 10000 | Croatia

+385 99 5450 425 | [www.starfitnesshr](http://www.starfitnesshr) | [orlando@starfitness.hr](mailto:orlando@starfitness.hr)

**LMX.**